

Hyperspectral Imaging Microscope

ATH5010

Features:

- Spectral Range: 400-1000nm
- Spectral Resolution: <2.6nm 或 4nm(ATP9020)
- Wide FOV: 23.5°@f=35mm(Relate to Objective)
- IFOV: 0.9mrad@f=35mm(Relate to Objective)
- User-friendly structure and outlook design
- Super stability of integrated design
- High quality 3WLED illumination can ensure stable and long life span
- HD CCD camera provides HD specimen images
- Spectral analysis and images scan, which improve time efficiency and avoid multiple data processing and loss.
- True colorful pictures processing and analysis

Application:

- Medical Institute, Cancer tissue sorting, blood cell categories
- Research institute, Universities and colleges
- Pharmaceutical companies, Chinese medicine fake or true
- Food Safety, Meat origin ID
- Micro plastics identification
- Minerals sorting
- Forensic identification, Documents identification
- Biological science, bacteria, cell analysis
- material science, micro materials detection

Description:

ATH5010 is self-developed hyperspectral imaging microscope with compact size, HD, high quality, it consists of microscope, hyperspectral imager and data processing work station.

ATH5010 employs 1920X1080 pixels high performance CCD imaging component, clear images, low noise, the integrated exclusive high compression images algorithm can improve database storage.

Hyperspectral imaging technology provides spectral images with fast, accurate, and high spectral and spatial resolution, and universality. It can widely applied to medicine, pathology, pharmaceutical, life science etc. As well as medical institute, research science, medical college, pharmaceutical companies laboratory research equipment.

Models	Features
ATH5010	Upright Microscope
ATH5010INV	Inverted Microscope
ATH5010OPN	Scientific-grade

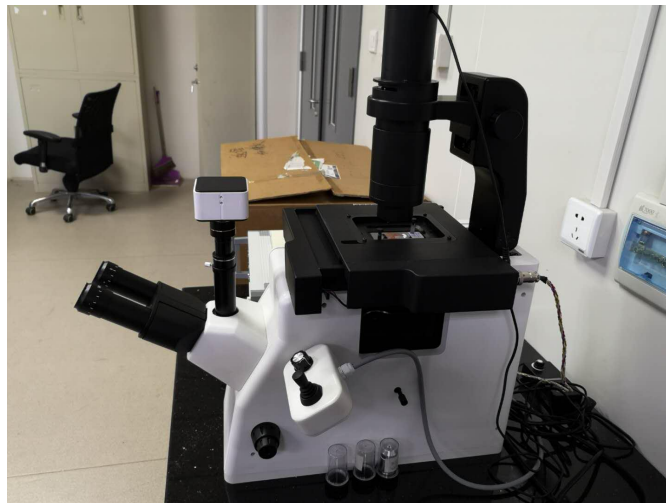
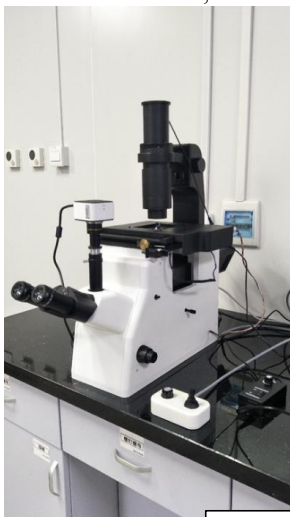

ATH5010 (a) ATH5010INV; (b) ATH5010INV; (c) ATH5010

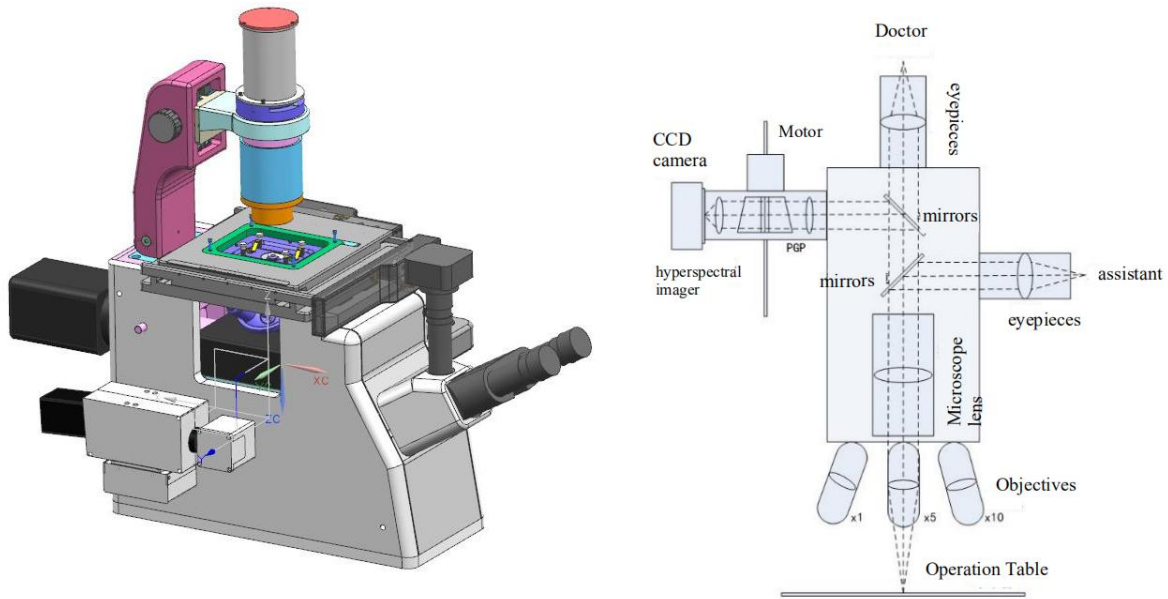

Fig: Hyperspectral imaging system structure and optical path principle

This is the principle of hyperspectral imager, the target object to be detected on the operation table going through objectives and microscope lens sets, then being divided into three optical paths, the first path is used for reviewing by chief surgery, the second path is used for reviewing by the assistant, the third path is used for collection by hyperspectral imager, which is driven by motor to perform spatial scanning on the target, after obtaining the spectral imaging information to process the database to be displayed to the chief surgery.

1. Technical Specification

1. Imaging Spectrometer Module

Spectral Range	400-1000nm
Spectral Resolution	<3nm
Spatial Resolution	<2mrad
Spectral Channels	270 (Max. 1280)
Spatial Pixels	480 (Max. 1920)
Images Size	7.8mm×14.2mm
NA	F/2.4
A/D	12bit
FOV Overlap	Shift < 10% of FOV diameter of microscope
Cleanliness	No obvious pitting, scratches, bubbles and other defects that obviously affect the observation in the field of view, and no obvious broken edges,

	oil stains and attachments of optical parts
Equipment inclined degree	Normal work < 10°
Stability	Stable and firm stand support, movement, moving parts
Voltage	Rated voltage<500V, voltage shift<±10%
EMC Test	Pass
Temperature	+10°C~+40°C
Humidity	30%~75%
Air Pressure	700hPa~1060hPa

(2) Microscope Module

Optical System	Infinite chromatic aberration-corrected optical system/common-corrected optical system
Observer head	Siedentopf type binocular or trinocular head, 30°inclined,Interpupillary: 50-75mm
Eyepieces	PL10X/22mm High eye-point wide field plan eyepiece, PL20X/12mm High eye-point wide field plan eyepiece total 2 pairs, Diopter adjustment ±5 , tube:Φ30mm
Magnification	40~2000 times (total 8 classes)
Objectives	Infinite wide field plan achromatic objective 4X,10X,40X,100X
Nosepiece	Inner 4 or 5 holes
Condenser	abbe condenser (optional plug-in phase contrast conversion, dark field condenser interface, polarized port)
Stages	220×148mm double-layer stage X -axis steel wire mechanical moving stage, moving range: 76X50mm,precision 0.1mm, two-slice is available
Condenser Mechanical	Coaxial Coarse and Fine Adjustment, Fine Division 0.002mm
Illumination System	3WLED brightness continuously adjustable Köhler Illumination system
Digital camera imaging system	5-mega Camer, HD digital USB port, clear and smooth images, Connectable to computer to imaging and taking pictures, videos, measurement, edit, save and print.

2. Accessories Lists:

S/N	Items	Qty	Optional
1	Hyperspectral Microscope (400-1000nm) Host	1set	Included
3	Objectives and Radiance Calibration	1set	Included
4	Work Service Station (Operation Controller and software)	1set	Included
6	Halogen lamp	4 units	Included
7	Standard Calibration Board	1 pieces	Included

3. Application Case

3.1 Tumor tissue detection

Hyperspectral imaging microscope integrates 2D spatial pictures to 1D spectral signal to form 3D cubic database. By combining spectral and imaging technology, hyperspectral images reveal how materials or its molecule in electromagnetic wave absorb and reflect the lights. It not only includes rich spatial information, but also includes spectral features in the continuous narrow wavelength range. It can accurately identify blooded cells. At present, hyperspectral imaging microscope technology has been widely applied to Tongue tumors, intestinal ischemia and cancer, hemorrhagic shock, medical food safety and other diagnostic detection.

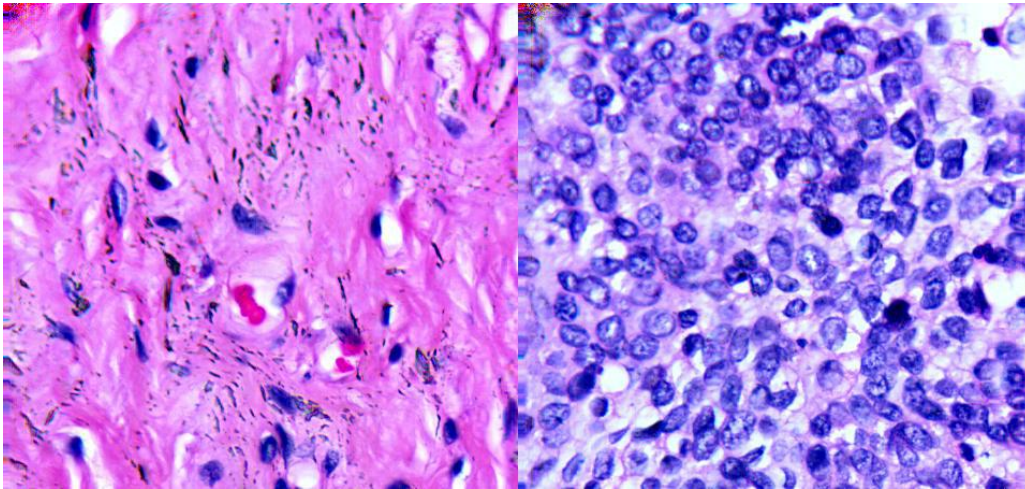

100XCervical cancer non-tumor section

100XCervical cancer tumor section

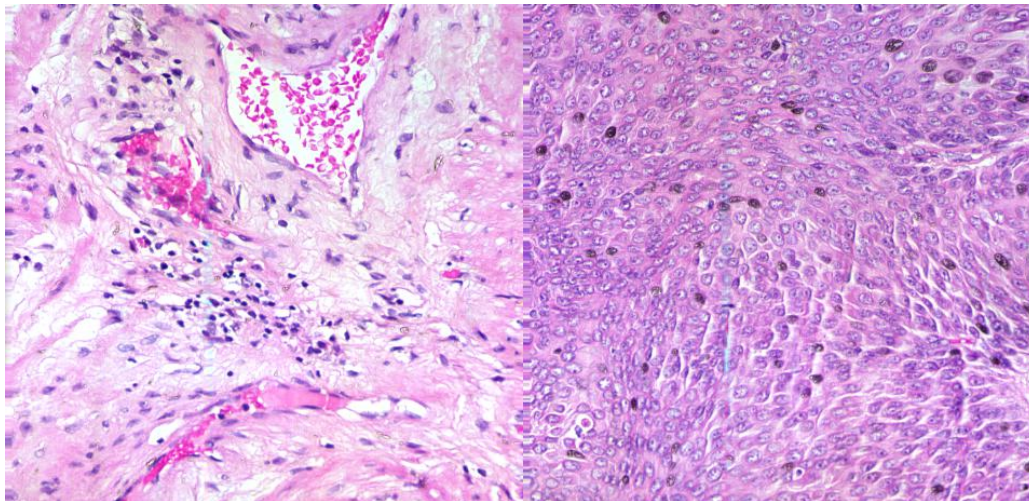

40Xbladder cancer non-tumor section

40X bladder cancer tumor section

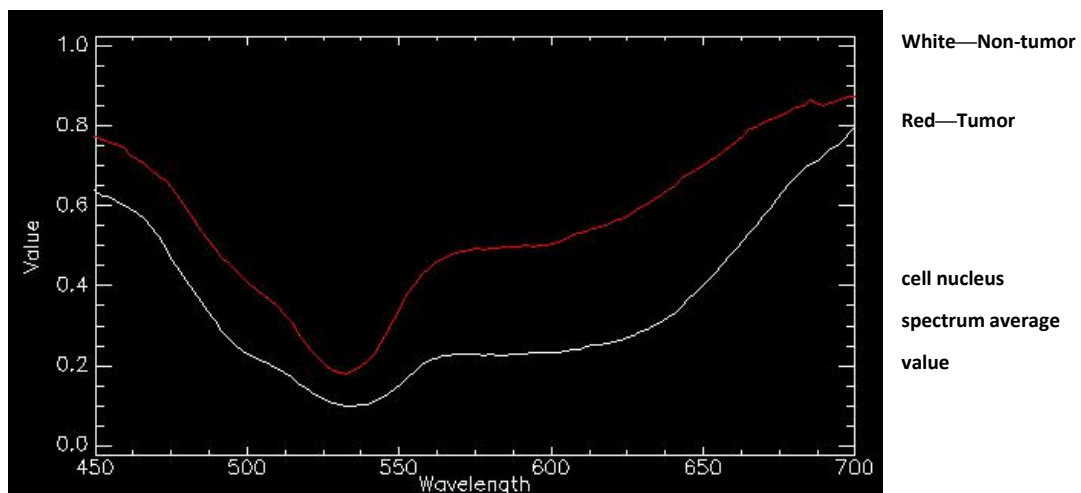

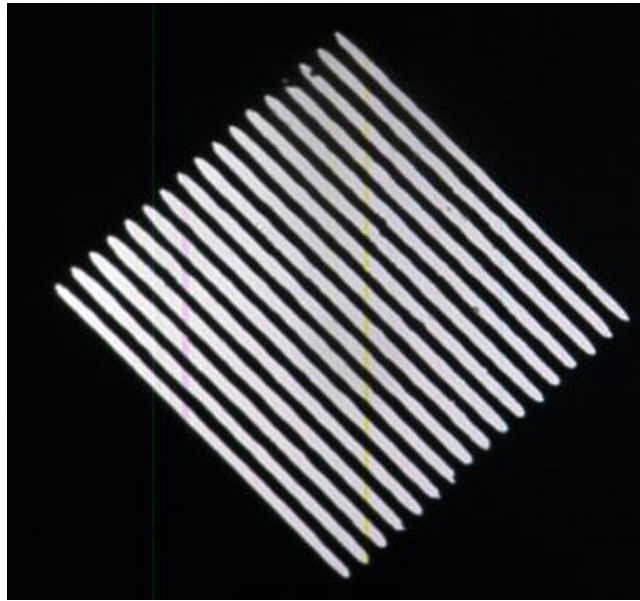

40Xresolution (2.5micron)

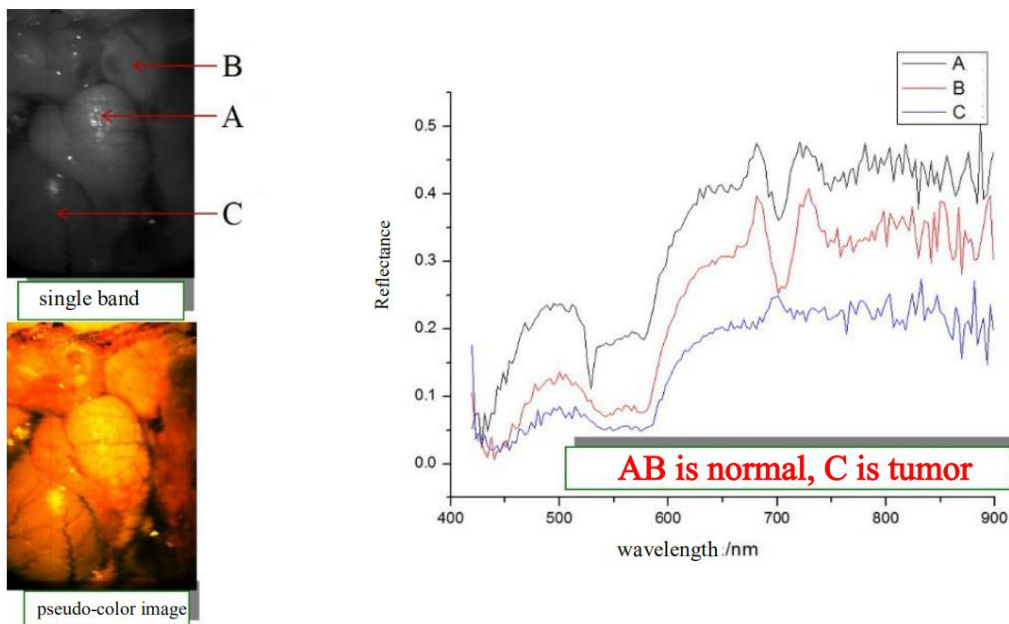

Hyperspectral Imaging Data

Cholangiocarcinoma is a relatively rare but extremely malignant tumor. Because the early symptoms are not obvious, patients often miss the best time for treatment when they find it. As the "gold standard" for the diagnosis of cholangiocarcinoma, pathological diagnosis is mainly performed by experienced physicians on pathological slices with tedious and time-consuming microscopy. In this process, misdiagnosis or missed diagnosis may be caused due to inexperienced physicians in reading films or different evaluation criteria . As an

emerging technology, hyperspectral imaging technology can simultaneously obtain spatial and spectral information of samples to be collected. Duan Yipan and others at East China Normal University have done more in-depth research.

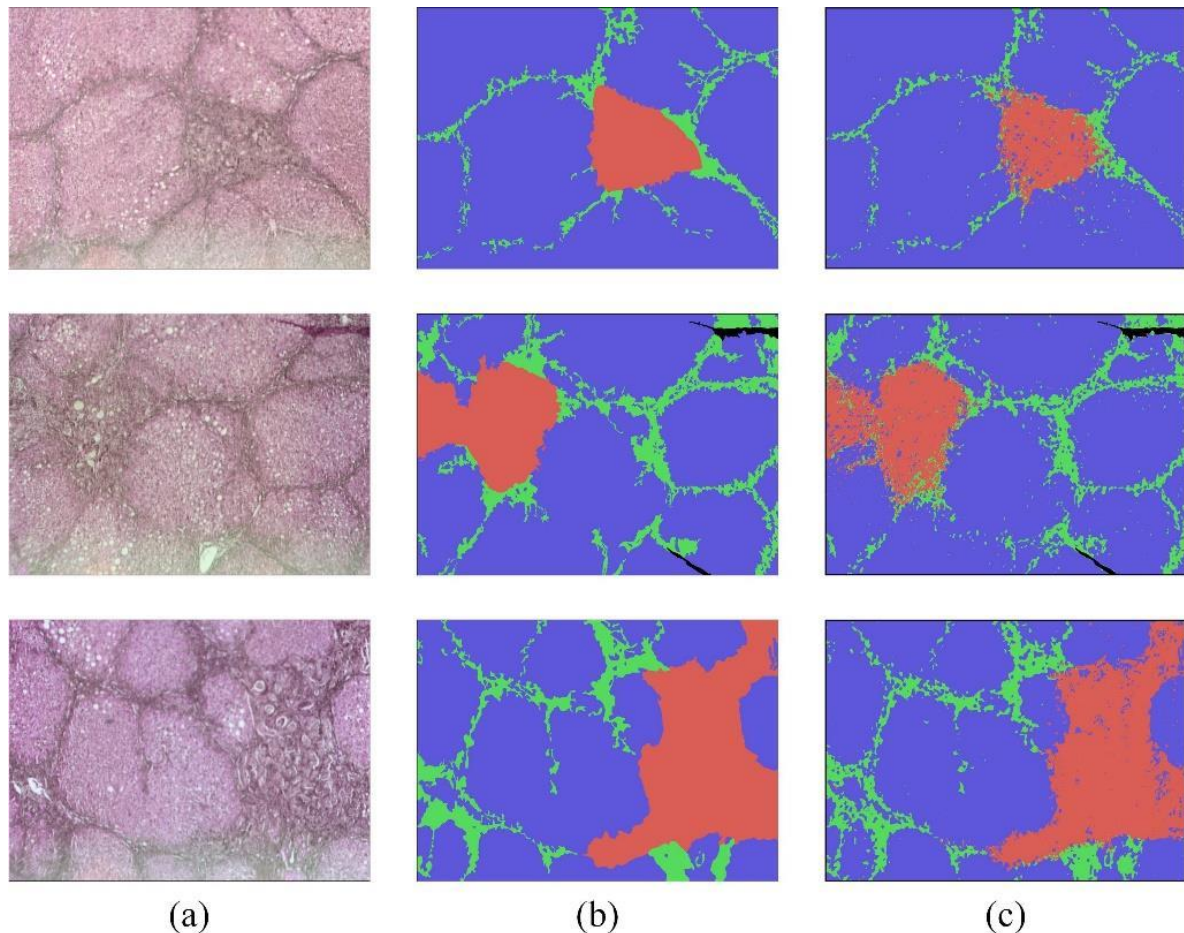

Fig 6 The results of recognition of cholangiocarcinoma tissue by Duan Yipan et al. with hyperspectral imaging microscope (a) pseudo-color composite image (b) manual annotation of the corresponding image (c) 3D-Res-CNN region of the corresponding image Recognition result

3.2 Hyperspectral Microscope Applied To Blood Cell

Blood cell classification plays a huge role in diagnostics. For example, the recognition of cell profile is associated with a specific disease, and the count of white blood cells has been shown to be associated with a variety of diseases, including obesity, smoking, allergic asthma, etc. Initially, blood cell classification and counting were performed manually under a microscope, which was time-consuming and had a high error rate. Automatic blood cell classification can be realized with digital microscopic imaging technology. Due to the similar shapes of different types of blood

cells, the accuracy and specificity of cell classification still pose challenges to traditional microscopic imaging techniques. Medical hyperspectral images combine two-dimensional spatial images and one-dimensional spectral signals into a three-dimensional data cube. Combining spectroscopy and imaging technology, the essence of medical hyperspectral images is to reflect materials and how they absorb and reflect light under molecular-level electromagnetic waves. It not only includes rich spatial information, but also contains many continuous narrow bands called spectral features, which can accurately distinguish different blood cells. At present, medical hyperspectral imaging technology has been applied to the detection of tongue tumors, intestinal ischemia and cancer, hemorrhagic shock, medical food safety and other diagnostics.

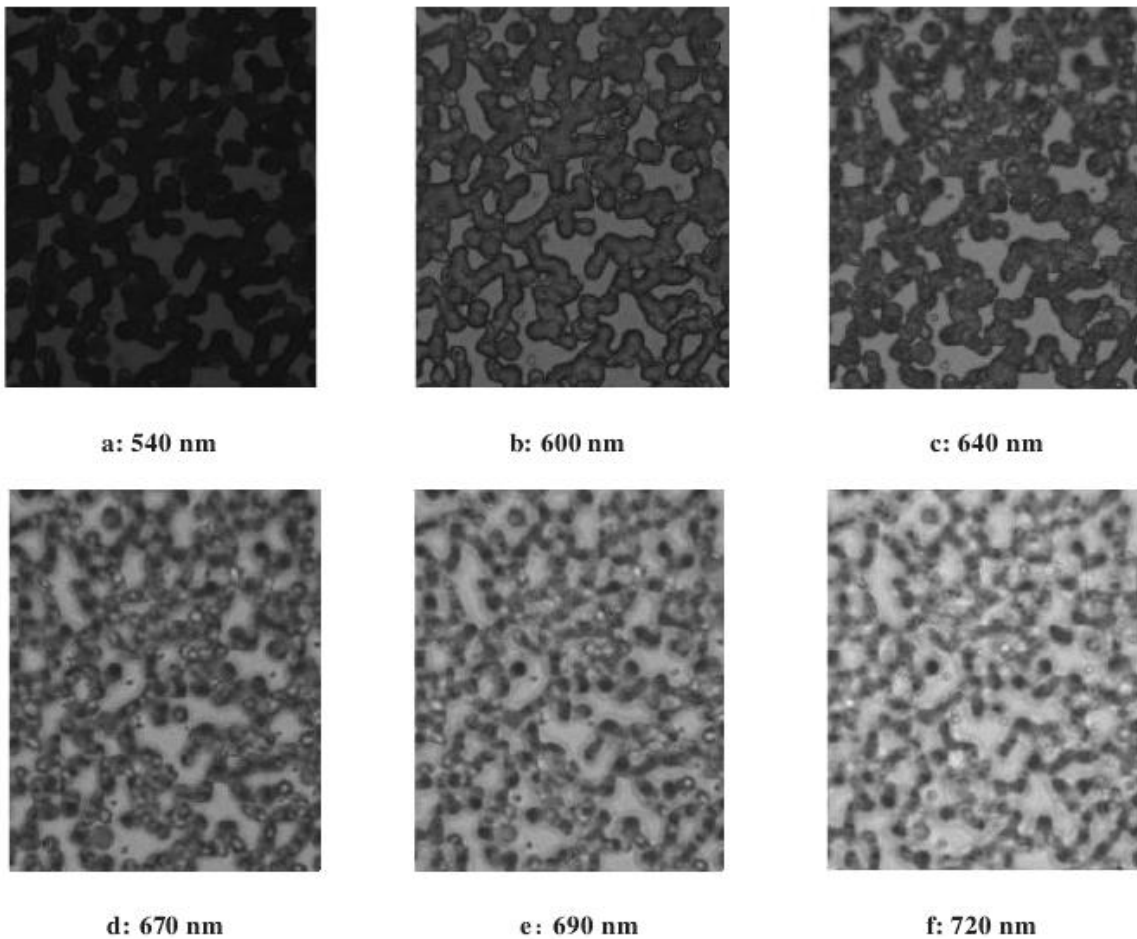

Fig 7 Hyperspectral Microscope images in different bands

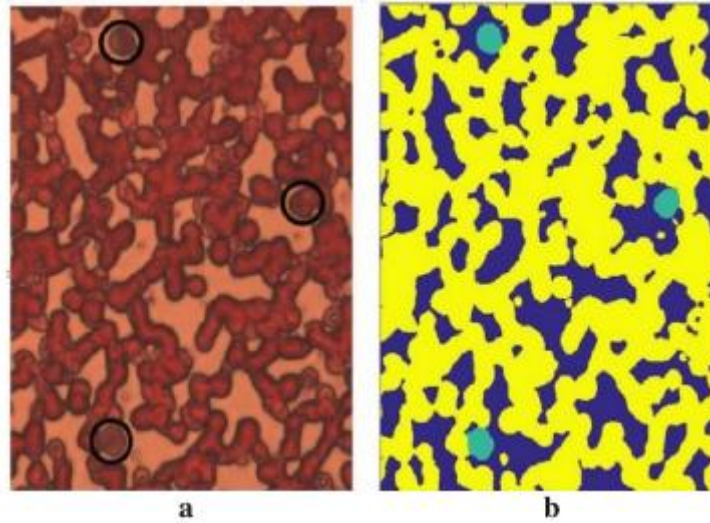
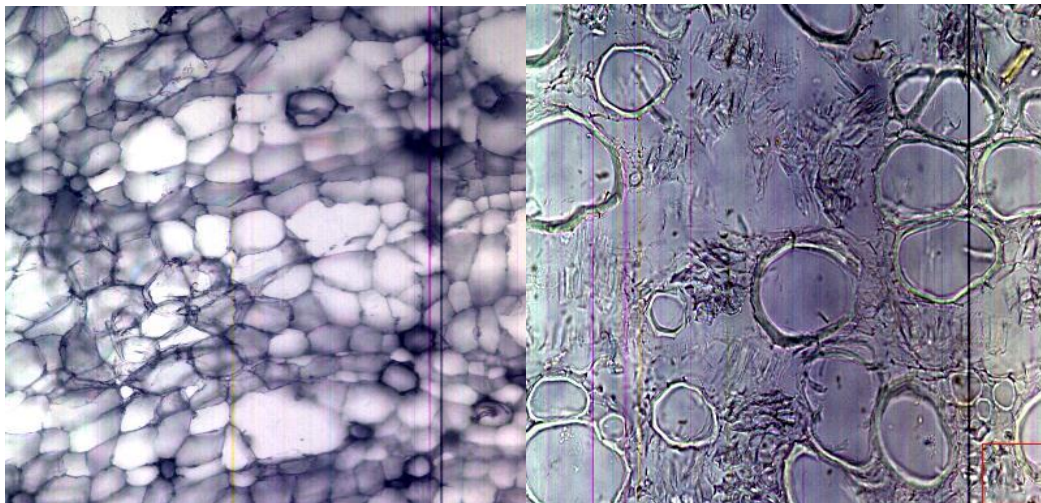

Fig 8 (a)Background, White and Red cell pseudo-color images(b) distribution

3.3 Hyperspectral Microscope Applied To Chinese Traditional Medical Materials



40X fresh Chinese angelica frozen section

40X dewaxing Astragalus section

3.4 Hyperspectral Microscope Applied to Wood Species Classification

In wood trading activities, the identification of wood species and the determination of species grades have always been a difficult task that requires practical experience. The

properties, physical properties and prices of different species of wood vary greatly. Hyperspectral imaging has the advantages of multiple bands, high resolution and integration of spectrum and maps. It integrates spectral and spatial information and has been applied in the field of remote remote sensing classification and sample tissue composition detection. Zhao Peng and others of Northeast Forestry University used hyperspectral microscope and Composite Kernel SVM function algorithm to achieve a classification accuracy of about 95%.

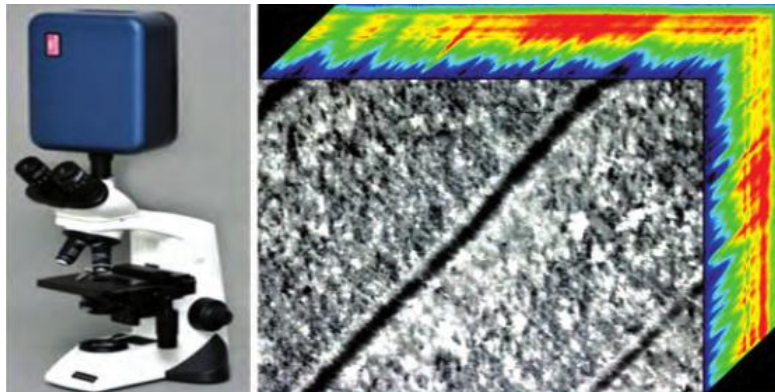

Fig 10 Hyperspectral Microscope System; (a): Hyperspectral Imager; (b): Hyperspectral cubic images database (Merbau wood in Indonesia)

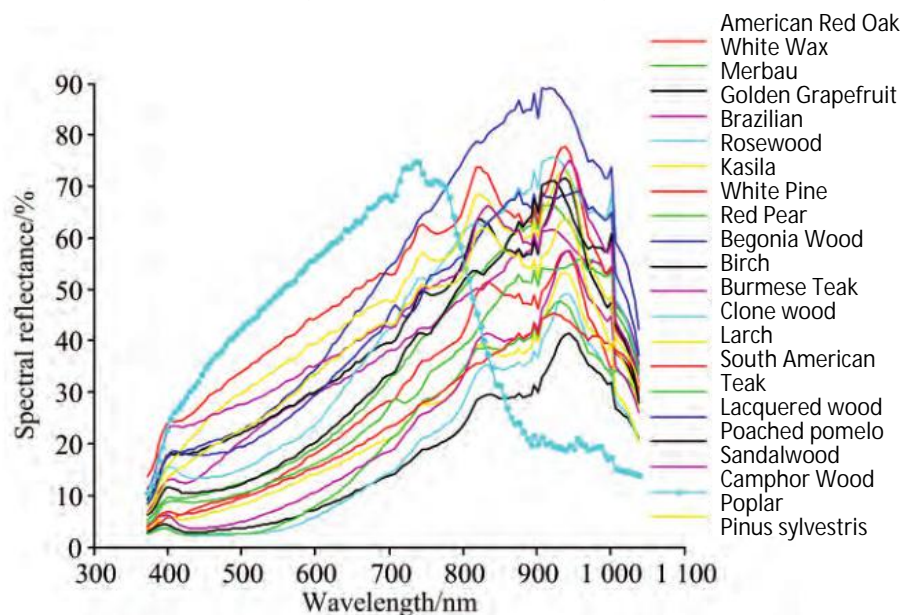

Fig 11 20 classes of woods specimen average spectral curves

3.5 Hyperspectral Microscope Applied to LED 2D Joint Temperature Detection

With the rapid development of LEDs, thermal management has always been the focus of

research. The highest temperature part of LED devices is the P-N junction. Excessive junction temperature will seriously affect the performance of the LED, and even cause damage to the LED. Since the surface of the LED is usually covered by a package, temperature measurement can only be achieved by non-contact means. The Lu Yijun research group of Xiamen University innovatively uses microscopic hyperspectral scanning to detect the two-dimensional junction temperature of LEDs. The microscopic hyperspectral can realize non-contact measurement without changing the working state of the LED itself. The sample to be tested is irradiated with incident light and the reflected light is collected. The test can be completed without directly contacting the LED sample to be tested. For bare LED chips with small surface area and fragile chip structure, direct contact with easily damaged chips, this method danger is avoided, and junction temperature testing can be performed on chips with transparent packages.

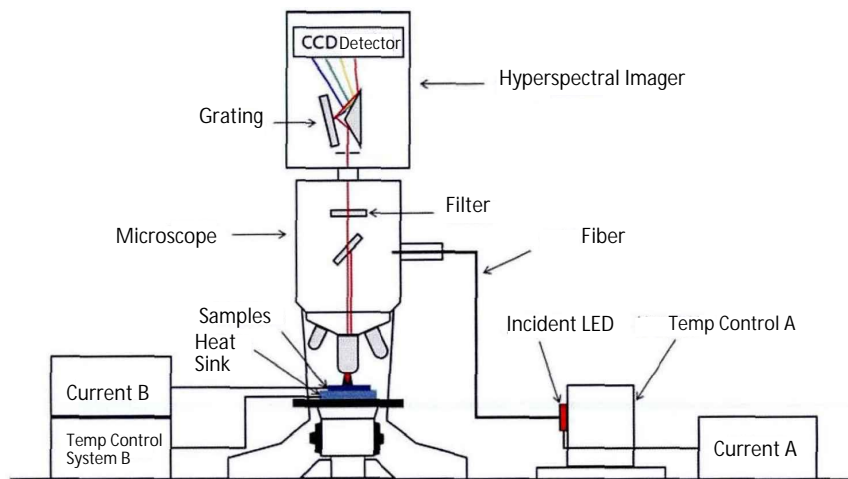
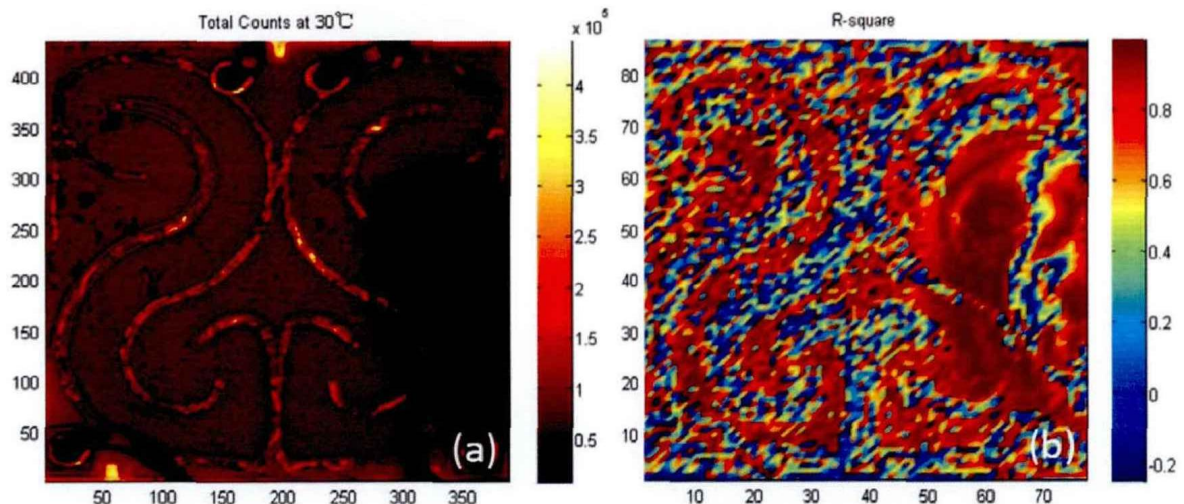

Fig 3-9 Hyperspectral Microscope Joint Temperature Lab Setup figure



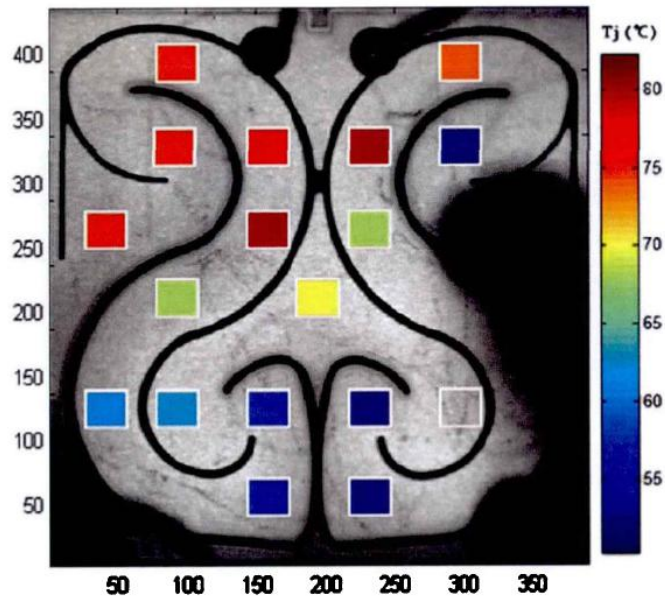

Fig 12 The Lu Yijun research group of Xiamen University measure LED 2D joint temp (500mA temperature distribution condition)
2.5 μm resolution (40XObjective)